

Submittal Data Sheet

CS-Z9AKUAW

Mini Split Indoor Unit

Job Name: _____
 Location: _____
 Engineer: _____
 Submitted to: _____
 Submitted by: _____
 Reference: _____

Approval: _____
 Date: _____
 Construction: _____
 Unit #: _____
 Drawing #: _____

Power Supply	
Power Supply (V/PH/Hz)	208-230 / 1 / 60

Noise Levels	
Cooling:	
Indoor Noise (H / L / QLo) dB (A)	42 / 25 / 19
Indoor Power Level (dB)	58
Heating:	
Indoor Noise (H / L / QLo) dB (A)	42 / 29 / 19
Indoor Power Level (dB)	58

Indoor Fan Stats	
Fan Type	Crossflow Fan
Motor	DC (8-poles)
Input Power (W)	47.3
Output Power (W)	30

Indoor Fan Speeds	
QLo Cool / Heat (rpm)	490 / 500
Lo Cool / Heat (rpm)	630 / 710
Med Cool / Heat (rpm)	850 / 910
Hi Cool / Heat (rpm)	1070 / 1130
SHi Cool / Heat (rpm)	1120 / 1180

Indoor Airflow	
QLo Cool / Heat (CFM)	148 / 152
Lo Cool / Heat (CFM)	210 / 247
Med Cool / Heat (CFM)	309 / 337
Hi Cool / Heat (CFM)	410 / 435
SHi Cool / Heat (CFM)	431 / 458

Indoor Heat Exchanger	
Fin Material	Aluminum (Pre-Coat)
Fin Type	Silt Fin
Row x Stage x FPI	2 x 17 x 21
	1 x 4 x 21 (sub eva)
Size (W x H x L) (in)	25-3/8 x 3-47/64 x 1/2 (sub eva)

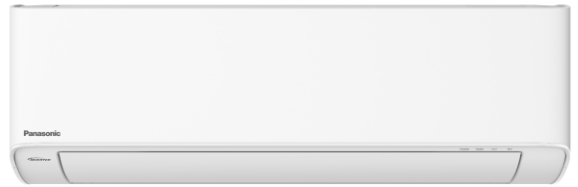

Intertek



Indoor Operating Range		
Cooling	Dry Bulb	Wet Bulb
Minimum °F (°C)	60.8 (16)	51.8 (11)
Maximum °F (°C)	89.6 (32)	73.4 (23)
Heating		
Minimum °F (°C)	60.8 (16)	-/-
Maximum °F (°C)	86.0 (30)	-/-

Dimensions and Weight	
Height x Width x Depth (in)	11-5/8 x 34-9/32 x 9-1/32
Weight (lb.)	24

Piping Metrics	
Pipe Diameter Liquid / Gas (in)	
- Liquid	1/4"
- Gas	3/8"
Standard Length (ft.)	25
Length Range (ft) (min-max)	10 - 66
Indoor (CS) & Outdoor (CU) Max Height Difference (ft)	49.2
Additional Gas Amount (oz/ft)	0.1
Length for Additional Gas (ft)	25
Drain Hose	
- Inner Diameter (in)	0.66
- Length (in)	25.6

Indoor Dimensions

<Top View>

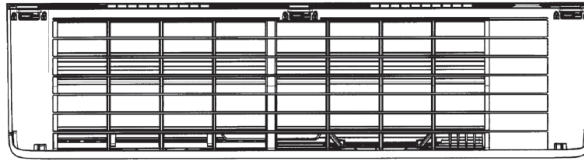

<Side View>

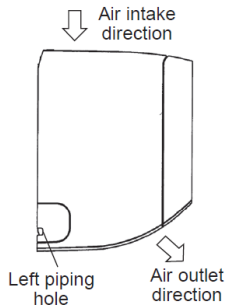

<Front View>

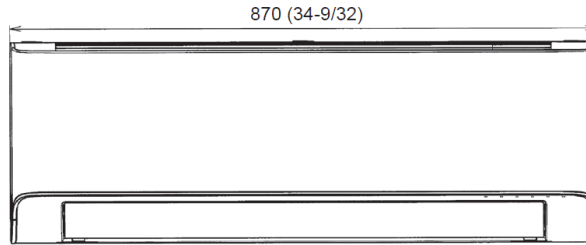

<Side View>

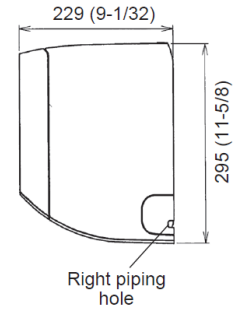

<Bottom View>

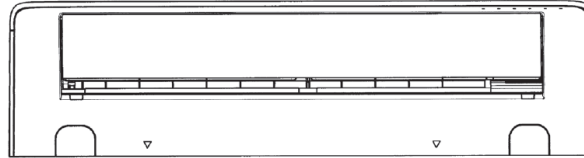

<Remote Control>

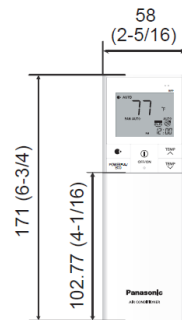

<Rear View>

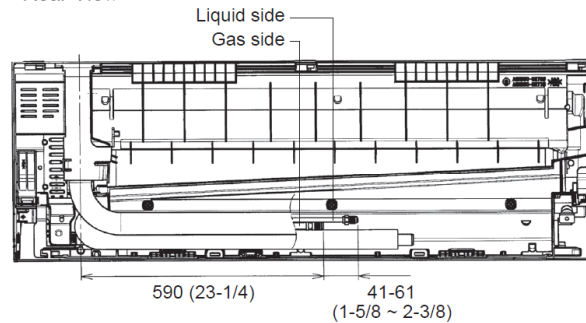

<Remote Control Holder>

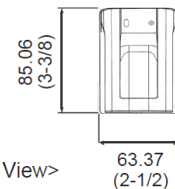

Relative position between the indoor unit and the installation plate <Front View>

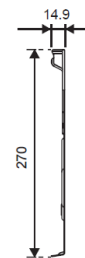
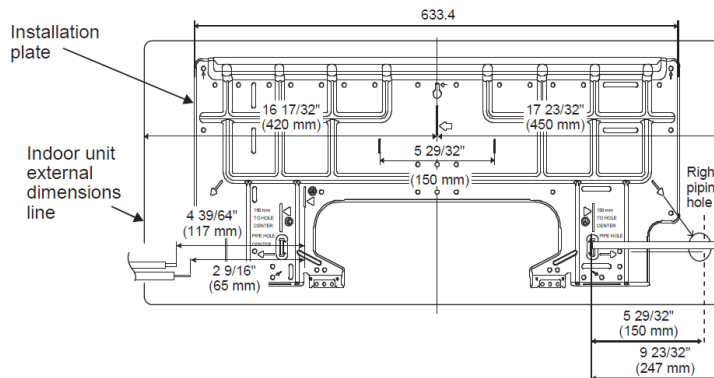

Unit: mm (inch)

Panasonic Canada

5770 Ambler Drive
Mississauga, ON L4W 2T3

<https://na.panasonic.ca/indoor-air-quality/hvac>

breathe well

The Only Complete Air Quality Solution™